

TOILET ROLL HOLDER WP157



163 x 170 x 100 mm
for 1 toilet roll

- Toilet roll holder in robust, germ-reducing and easy-care stainless steel (AISI 304).
- All-stainless steel construction, visible surfaces satin finished and brushed.
Further available surfaces: see below.
- Designed for one standard toilet roll with dimensions:
Outer diameter max. 125 mm
Width max. 100 mm
Core diameter min. 38 mm
- Accessible for refilling by unlocking the center axis.
- Installation dimensions: 145 x 152 x 100 mm
- Mounting: With four screws in wall opening through fixing holes in the side walls.
- Delivery includes fixing material.
- Weight, including single package: 0.7 kg



Suggested text for specifications:

Toilet roll holder in stainless steel (AISI 304) for flush mounting. All-stainless steel construction, visible surfaces satin finished and brushed. Designed for one standard toilet roll. Accessible for refilling by unlocking the center axis. Delivery includes fixing material.

Dimensions: 163 x 170 x 100 mm

Article No. WP157

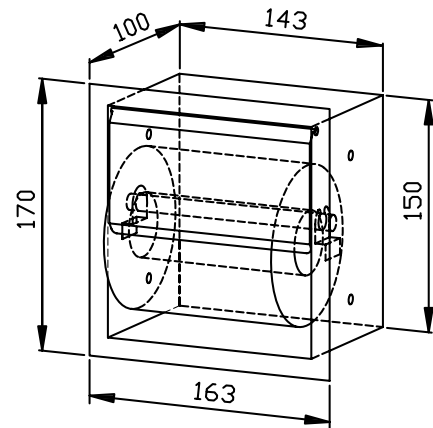

Available surfaces	ID No.
satin finished (standard)	727 740
highly polished	731 740
(coloured) plastic powder-coating	728 740

Ernst Wagner GmbH & Co. KG

Ernst-Abbe-Straße 21 · D-72770 Reutlingen · Tel.: +49712151539-0 · Fax: -20
info@wagner-ewar.de · www.wagner-ewar.de

WAGNER
EWAR